

Kuhnke FIO analoge I/Os - CoE

Control Technology

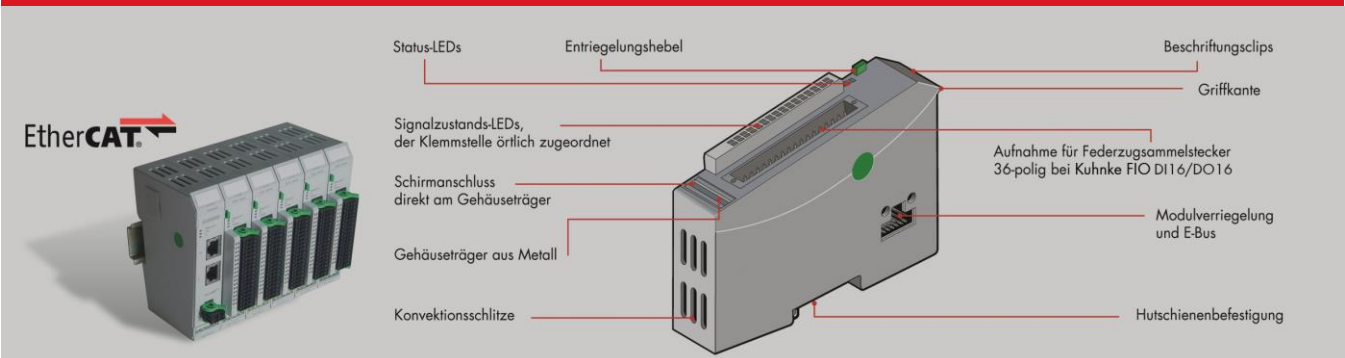

Technische Daten

Typ	Eingangsmodule				Ausgangs- module	Ein- / Ausgangs- module
Bestellnummer	694 441 51	694 441 52	694 441 53	694 441 54	694 442 52	694 444 65
Kanäle / Kanaltyp	4 / Strom	4(8) / Spannung	8(16) / Spannung	8 / Strom	4 / Strom + Spannung	4 + 4 / Strom + Spannung
Auflösung	12 Bit	13 Bit	13 Bit	12 Bit	16 Bit	12 Bit / 16 Bit
Eingangsbereich (einstellbar pro Kanal) Unipolar / Bipolar	0(4)...20 mA	0...10 V / -10...+10 V	0...10 V / -10...+10 V	0(4)...20 mA		0(4)...20 mA 0...10 V
Ausgangsbereich (einstellbar pro Kanal) Unipolar / Bipolar					0(4)...20 mA 0...24 mA 0...10 V / -10...+10 V	0(4)...20 mA 0...10 V / -10...+10 V

Typ	Temperatur Eingangsmodule	
Bestellnummer	694 443 57	694 443 57
Kanäle / Kanaltyp (einstellbar pro Kanal)	4 / PT100 / Ni100 oder PT1000 / Ni1000 oder Thermo / Typ J, K oder mV	4 / PT100 / Ni100 oder PT1000 / Ni1000 oder Thermo / Typ J, K oder mV
Auflösung	16 Bit	16 Bit
Feldbusanschluss	EtherCAT® 100 Mbit/s LVDS: E-Bus	
Montage	35 mm DIN Schiene	
Signalanzeige	LED, der Klemmstelle örtlich zugeordnet	
EMV-Festigkeit / - Aussendung	gemäß EN 61000-6-2/ EN 61000-6-4	
Schirmanschluss	Direkt am Modul	
Anschlussklemmen	Federzugsammelstecker mit mechanischem Auswerfer	
Umgebungsbedingungen	0 °C...+55 °C, IP 20, Störfestigkeit Zone B nach EN 61131-2	
Gehäuse (B x H x T)	Aluminiumträger, Kunststoff 25 x 120 x 90 mm	
Zulassungen	CE, cULus	

We reserve the rights of modification, omission, error with respect to the products. Illustrations similar. All rights reserved by the individual copyright holders. EtherCAT® is registered trademark and patented technology, licensed by Beckhoff Automation GmbH, Germany. Safety over EtherCAT® is registered trademark and patented technology, licensed by Beckhoff Automation GmbH, Germany. Microsoft®, Windows® and the Windows® Logo are registered trademarks of Microsoft Corporation in the USA and other countries. At www.plcopen.org you will find more information about PLCopen Organisation. CODESYS is a product of 3S-Smart Software Solutions GmbH. CIA® and CANopen® are registered community trademarks of CAN in Automation e.V. PROFINET® is a registered trademark of PROFIBUS and PROFINET International (PI).